



# **G-PROT**

Filters for EMC / EMI / Tempest Applications

GP-Series	General Performance
HP-Series	High Performance
LE-Series	Low Earth Leakage
TE-Series	Tempest
VP-Series	Very High Performance

# GP Shielded room filters

Current Ratings: **3,6,10,16,25,32,50,63,80,100,200,225, 400, 600, 1000+ AMPS.**  
 Operating Voltage: Single Phase, Two Phase & Three Phase. 230V to 440V.A.C.

The GP (general performance) filter range are designed and tested for shielded room requirements, for attenuation from 100kHz – 1GHz at 100dB, this range of filters will also keep attenuating up to 40GHz and beyond.

Shielded rooms require high levels of attenuation to ensure no conducted / radiated emissions are either imported or exported from the room. The filters come in 2, 3 or 4 line formats and have current ratings up to 3000Amps per phase. Transient suppression can be added as an option to the filters to give protection against induced transients from EMP sources.

The filters are housed in steel enclosures that are then painted for protection.



## TYPICAL APPLICATIONS

- Shielded enclosures
- IT installation
- Computer rooms
- Banks
- Military installations

## COMMERCIAL ADVANTAGES

- Assists compliance with the EMC directive
- State of the art technology ensures superior performance
- Competitively priced
- Compact size - Reduced weight - Cost effective component

## TECHNICAL ADVANTAGES

- High current capability - Micro size
- High common & differential mode insertion loss
- Improved low frequency performance
- Optional input transient suppression to suit application

## Technical Specifications

Current (Amps)	No of Lines	Max Voltage / Frequency		Max AC Volt Drop @ Full Load	Typical Earth Leakage mA (Worst Case)			Inductance Per Line (Typical) mH	Transient Energy Absorption (Typical)	Storage Temp Range	Operating Temp.	Temp Rise @ Full Load	Termination Type	Weight (Kg) (approx) (GP filters)	
		2 LINE	3 / 4 LINE		Std	LE	400 Hz							2 Line	4 line
3 - 6	2/3/4	275V AC	440V AC	<2V/Line	100	10	100	7	50J Optional	-25 ~ +85°C	-20 - +50°C	<35°C	M5 BOLT	3	8
10 -16					100	10	100	5	75J Optional				M5 BOLT	4	8
25 - 32					250	10	250	3	75J Optional				M6 BOLT	8	8
50 - 63					500	20	500	2	75J Optional				M8 BOLT	8	8
80 -100					1000	20	1000	0.7	150J Optional				M10 BOLT	25	28
200					1000	20	2000	0.3	150J Optional				M10 BOLT	28	28
400					2000	40	3000	0.15	200J Optional				M16 BOLT	38	40

## STANDARDS

The GP range of filters are built in accordance with the relevant BS, VDE, UL, CE & CSA safety standards. This range also conforms to MIL-STD 220A and the electrical characteristics of Mil-F-15733. All Total EMC Products filters & power supplies are designed to meet the latest requirements for Health and Safety, Particularly EN 60939-2-2005.

## REGULATIONS

From the 15th of December 2004 all electrical/electronic apparatus - with few exceptions - sold or taken into service within the European Community must comply with the essential requirements of the EMC directive 2004/108/EC. Failure to do so is a criminal offence in the U.K.

### Dimensional Data

AMP	LINE 2	A mm	B mm	C mm	D mm	E mm	F mm	G mm	LINE 3	A mms	B mm	C mm	D mm	E mm	F mm	G mm	LINE 4	A mm	B mm	C mm	D mm	E mm	F mm	G mm
3 - 6		350	90	45	25	23	32.5	6		330	200	90	32	60	36	6		330	200	90	32	60	36	6
10 -16		350	90	45	25	23	32.5	6		330	200	90	32	60	36	6		330	200	90	32	60	36	6
25 -32		330	200	90	32	60	36	6		330	200	90	32	60	36	6		330	200	90	32	60	36	6
50 -63		330	200	90	32	60	36	6		550	410	150	50	120	45	10.5		550	410	150	50	120	45	10.5
80 -100		560	215	120	32	120	45	8.5		550	410	150	50	120	45	10.5		550	410	150	50	120	45	10.5
200		560	215	120	40	120	45	8.5		550	410	150	50	120	45	10.5		550	410	150	50	120	45	10.5
400		740	410	200	50	150	65	12		970	510	200	50	150	65	12		970	510	200	50	150	65	12

All Dimensions relate to GP filters only.

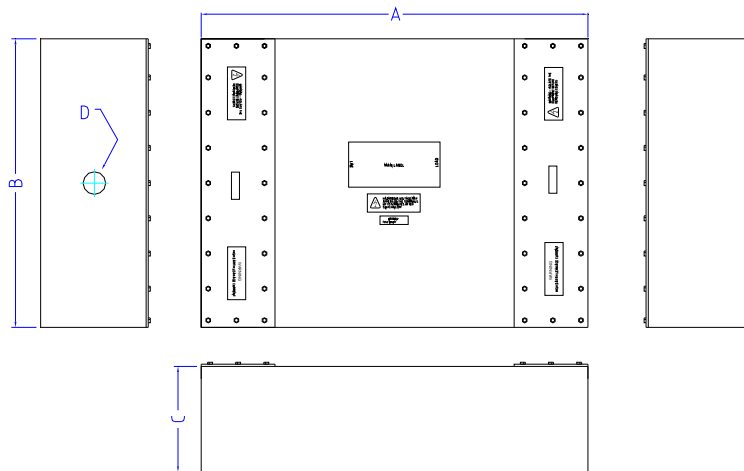

4 Line unit displayed

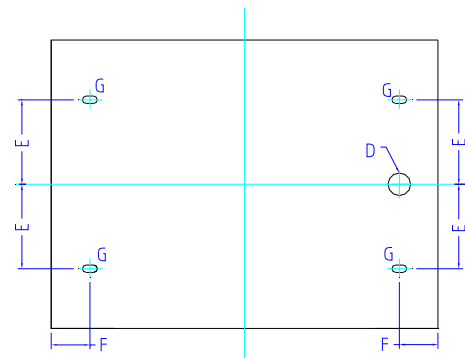

### Schematics

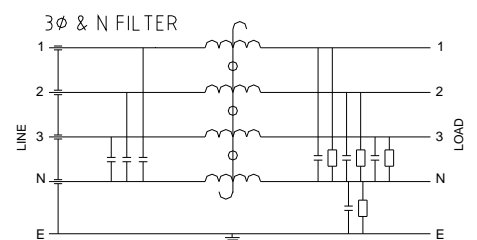
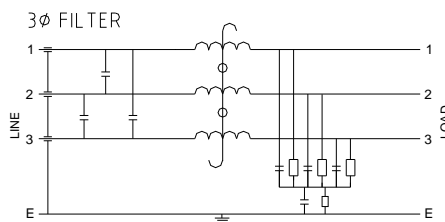
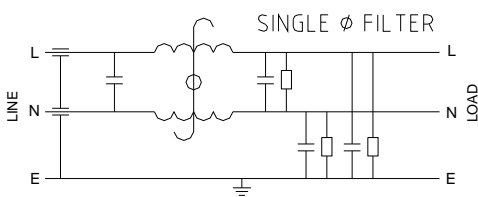

Performance characteristics insertion loss curves

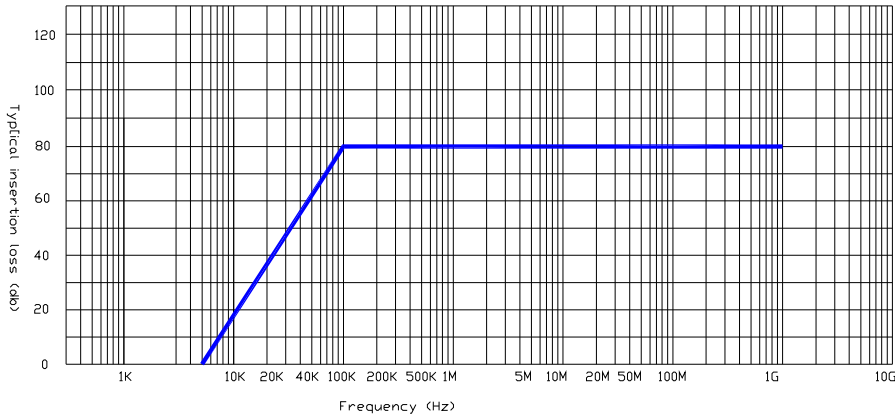

Additional Options – EMC Threaded bulkhead Gland

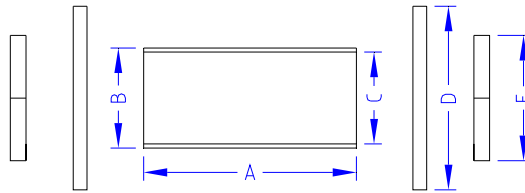

BULKHEAD GLAND DETAILS					
	A	B	C	D (Washer x 2)	E (Lock Nut x 2)
TYPE A	54mm	M25	22mm	44mm	30mm A/F
TYPE B	57mm	M20	17mm	36.5mm	24mm A/F
TYPE C	60mm	M32	29mm	TBA	TBA
TYPE D	60mm	M50	45mm	TBA	TBA
CUSTOM	Total EMC are able to supply custom gland options if required, please advise if you require custom Gland solution.				

Part number / Ordering information

\*\*\*/\*/GP/\*

\*\*\* = Amp Rating of filter      \* = No of Lines on filter (2,3,4)  
 \*\* = GP, General Performance      T = Transient Protection, - = None

Example: 016/3/GP/- (This is a 16A 3 line GP unit with no protection)

In addition to the standard range of filters & power supplies, Total EMC Products specialize in the design and manufacture of filters to suit your specific requirements. Due to continuous development Total EMC Products Ltd reserve the right to amend any information contained within this datasheet without prior notice.

© 10/2012 Total EMC Products Ltd. E & OE  
 The contents of the datasheet must not be copied by any means without prior written agreement.

# HP Shielded room filters

Current Ratings: **3,6,10,16,25,32,50,63,80,100,200,225, 400, 600, 1000+** AMPS.  
 Operating Voltage: Single Phase, Two Phase & Three Phase. 230V to 440V.A.C.

The HP (high performance) filter range are designed and tested for shielded room requirements, for attenuation from 100kHz – 10GHz at 100dB, this range of filters will also keep attenuating up to 40GHz and beyond.

Shielded rooms require high levels of attenuation to ensure no conducted / radiated emissions are either imported or exported from the room. The filters come in 2, 3 or 4 line formats and have current ratings up to 3000Amps per phase. Transient suppression can be added as an option to the filters to give protection against induced transients from EMP sources.

The filters are housed in steel enclosures that are then painted for protection.



## TYPICAL APPLICATIONS

- Shielded enclosures
- IT installation
- Computer rooms
- Banks
- Military installations

## COMMERCIAL ADVANTAGES

- Assists compliance with the EMC directive
- State of the art technology ensures superior performance
- Competitively priced
- Compact size - Reduced weight - Cost effective component

## TECHNICAL ADVANTAGES

- High current capability - Micro size
- High common & differential mode insertion loss
- Improved low frequency performance
- Optional input transient suppression to suit application

## Technical Specifications

Current (Amps)	No of Lines	Max Voltage / Frequency		Max AC Volt Drop @ Full Load	Typical Earth Leakage mA (Worst case)			Inductance Per Line (Typical) mH	Transient Energy Absorption (Typical)	Storage Temp Range	Operating Temp.	Temp Rise @ Full Load	Termination Type	Weight (Kg) (approx) (GP filters)	
		2 LINE	3 / 4 LINE		Std	LE	400 Hz							2 Line	4 line
3 - 6	2/3/4	275V AC	440V AC	<2V/Line	200	20	200	7	50J Optional	-25 ~ +85°C	-20 - +50°C	<35°C	M5 BOLT	3	8
10 -16					200	20	200	5	75J Optional				M5 BOLT	4	8
25 - 32					500	20	500	3	75J Optional				M6 BOLT	8	8
50 - 63					1000	40	1000	2	75J Optional				M8 BOLT	8	8
80 -100					2000	40	2000	0.7	150J Optional				M10 BOLT	25	28
200					2000	40	4000	0.3	150J Optional				M10 BOLT	28	28
400					4000	80	6000	0.15	200J Optional				M16 BOLT	38	40

## STANDARDS

The HP range of filters are built in accordance with the relevant BS, VDE, UL, CE & CSA safety standards. This range also conforms to MIL-STD 220A and the electrical characteristics of Mil-F-15733. All Total EMC Products filters & power supplies are designed to meet the latest requirements for Health and Safety, Particularly EN 60939-2-2005.

## REGULATIONS

From the 15th of December 2004 all electrical/electronic apparatus - with few exceptions - sold or taken into service within the European Community must comply with the essential requirements of the EMC directive 2004/108/EC. Failure to do so is a criminal offence in the U.K.

### Dimensional Data

AMP	LINE 2	A mm	B mm	C mm	D mm	E mm	F mm	G mm	LINE 3	A mms	B mm	C mm	D mm	E mm	F mm	G mm	LINE 4	A mm	B mm	C mm	D mm	E mm	F mm	G mm
3 - 6		350	90	45	25	23	32.5	6		330	200	90	32	60	36	6		330	200	90	32	60	36	6
10 -16		350	90	45	25	23	32.5	6		330	200	90	32	60	36	6		330	200	90	32	60	36	6
25 -32		330	200	90	32	60	36	6		330	200	90	32	60	36	6		330	200	90	32	60	36	6
50 -63		330	200	90	32	60	36	6		550	410	150	63	120	45	10.5		550	410	150	63	120	45	10.5
80 -100		560	215	120	32	53.75	45	8.5		550	410	150	63	120	45	10.5		550	410	150	63	120	45	10.5
200		560	215	120	32	53.75	45	8.5		550	410	150	63	120	45	10.5		550	410	150	63	120	45	10.5
400		740	410	200	50	150	65	12		970	510	200	50	150	65	12		970	510	200	50	150	65	12

All Dimensions relate to HP filters only.

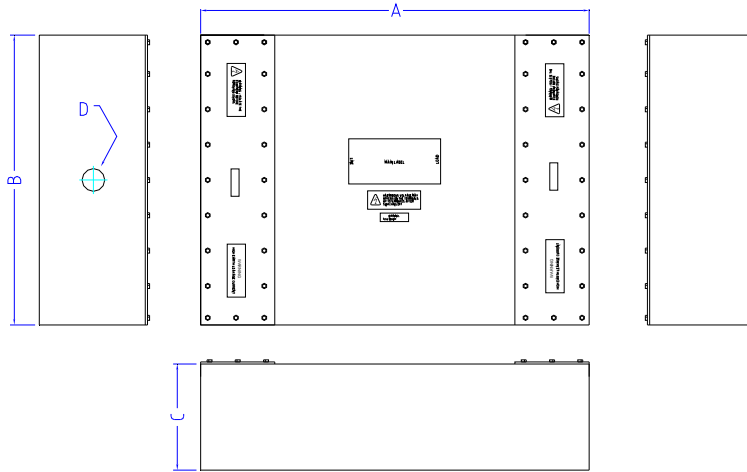

4 Line unit displayed

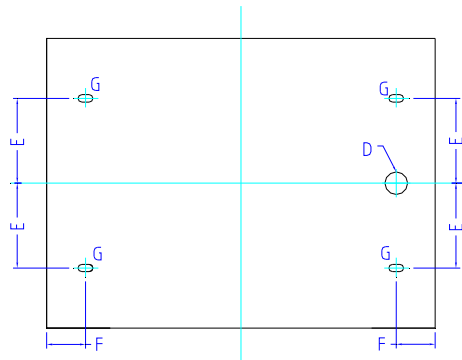

### Schematics

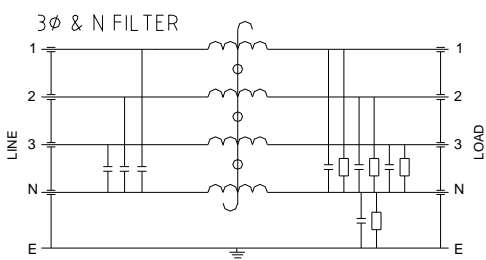
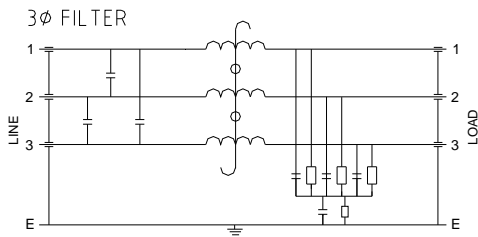
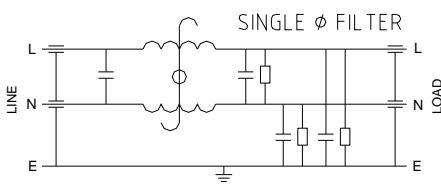

Performance characteristics insertion loss curves

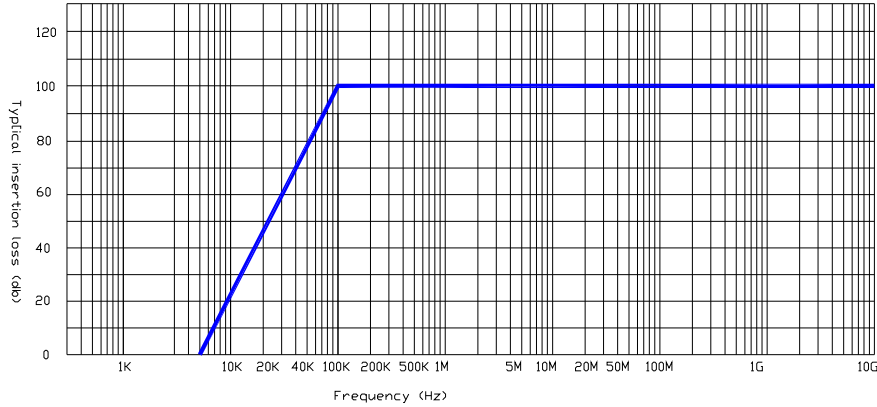

Additional Options – EMC Threaded bulkhead Gland

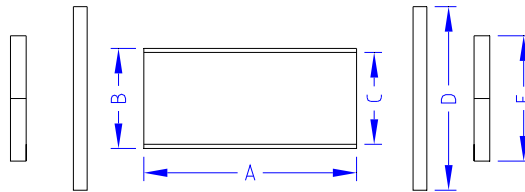

BULKHEAD GLAND DETAILS					
	A	B	C	D (Washer x 2)	E (Lock Nut x 2)
TYPE A	54mm	M25	22mm	44mm	30mm A/F
TYPE B	57mm	M20	17mm	36.5mm	24mm A/F
TYPE C	60mm	M32	29mm	TBA	TBA
TYPE D	60mm	M50	45mm	TBA	TBA
CUSTOM	Total EMC are able to supply custom gland options if required, please advise if you require custom Gland solution.				

Part number / ordering information

\*\*\*/\*/HP/\*

\*\*\* = Amp Rating of filter

\* = No of Lines on filter (2,3,4)

\*\* = GP, General Performance

T = Transient Protection, - = None

Example: 016/3/HP/- (This is a 16A 3 line HP unit with no protection)

In addition to the standard range of filters & power supplies, Total EMC Products specialize in the design and manufacture of filters to suit your specific requirements. Due to continuous development Total EMC Products Ltd reserve the right to amend any information contained within this datasheet without prior notice.

© 10/2012 Total EMC Products Ltd. E & OE  
The contents of the datasheet must not be copied by any means without prior written agreement.

# LE Shielded room filters

Current Ratings: **3,6,10,16,25,32,50,63,80,100,200,225, 400**, AMPS.

Operating Voltage: Single Phase, Three Phase and Three phase plus N. 230V to 440V.A.C.

The LE (Low earth leakage) filter range are designed and tested for shielded room requirements, for attenuation from 100kHz – 10GHz at 100dB, this range of filters will also keep attenuating up to 40GHz and beyond.

Shielded rooms require high levels of attenuation to ensure no conducted / radiated emissions are either imported or exported from the room. The filters come in 2, 3 or 4 line formats and have current ratings up to 400Amps per phase. Transient suppression can be added as an option to the filters to give protection against induced transients from EMP sources.

These filters are setup to specifically have low earth leakage for high levels of safety.

The filters are housed in steel enclosures that are then painted for



### TYPICAL APPLICATIONS

- Shielded enclosures
- IT installation
- Computer rooms
- Banks
- Military installations

### TECHNICAL ADVANTAGES

- High current capability - Micro size
- High common & differential mode insertion loss
- Improved low frequency performance
- Optional input transient suppression to suit application

### COMMERCIAL ADVANTAGES

- Assists compliance with the EMC directive
- State of the art technology ensures superior performance
- Competitively priced
- Compact size - Reduced weight - Cost effective component

## Technical Specifications

Current (Amps)	No of Lines	Max Voltage / Frequency		Max AC Volt Drop @ Full Load	Typical Earth Leakage mA (Worst Case)	Inductance Per Line (Typical) mH	Transient Energy Absorption (Typical)	Storage Temp Range	Operating Temp.	Temp Rise @ Full Load	Termination Type	Weight (Kg) (approx)	
		2 LINE	3 / 4 LINE		LE							2 Line	3/4 line
3 - 6	2/3/4	275V AC	440V AC	<2V/Line	10	7	50J Optional	-50 ~ +85°C	-50 - +50°C	<25°C	M5 BOLT	3	8
10 - 16					10	5	75J Optional				M5 BOLT	4	8
25 - 32					10	3	75J Optional				M6 BOLT	8	8
50 - 63					20	2	75J Optional				M8 BOLT	8	8
80 - 100					20	0.7	150J Optional				M10 BOLT	25	28
200					20	0.3	150J Optional				M10 BOLT	28	28
400					40	0.15	200J Optional				M16 BOLT	38	40

### STANDARDS

The LE range of filters are built in accordance with the relevant BS, VDE, UL, CE & CSA safety standards. This range also conforms to MIL-STD 220A and the electrical characteristics of Mil-F-15733.

All Total EMC Products filters & power supplies are designed to meet the latest requirements for Health and Safety, Particularly EN 60939-2-2005.

### REGULATIONS

From the 15th of December 2004 all electrical/electronic apparatus - with few exceptions - sold or taken into service within the European Community must comply with the essential requirements of the EMC directive 2004/108/EC. Failure to do so is a criminal offence in the U.K.



## Dimensional Data

AMP	LINE 2	A mm	B mm	C mm	D mm	E mm	F mm	G mm	LINE 3	A mms	B mm	C mm	D mm	E mm	F mm	G mm	LINE 4	A mm	B mm	C mm	D mm	E mm	F mm	G mm
3 - 6		350	90	45	25	23	32.5	6		330	200	90	32	60	36	6		330	200	90	32	60	36	6
10 -16		350	90	45	25	23	32.5	6		330	200	90	32	60	36	6		330	200	90	32	60	36	6
25 -32		330	200	90	32	60	36	6		330	200	90	32	60	36	6		330	200	90	32	60	36	6
50 -63		330	200	90	32	60	36	6		550	410	150	50	120	45	10.5		550	410	150	50	120	45	10.5
80 -100		560	215	120	32	120	45	8.5		550	410	150	50	120	45	10.5		550	410	150	50	120	45	10.5
200		560	215	120	40	120	45	8.5		550	410	150	50	120	45	10.5		550	410	150	50	120	45	10.5
400		740	410	200	50	150	65	12		970	510	200	50	150	65	12		970	510	200	50	150	65	12

All Dimensions relate to LE filters only.

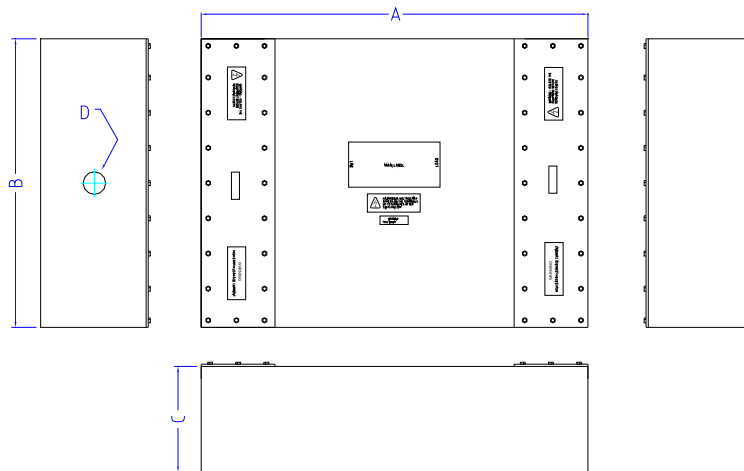

4 Line unit displayed

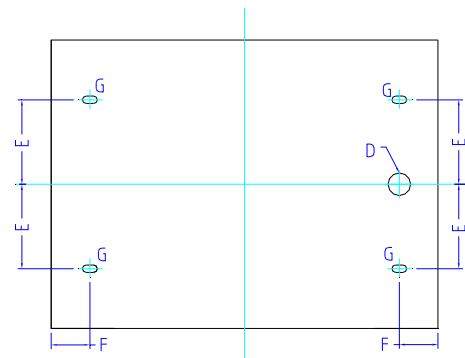

## Schematics

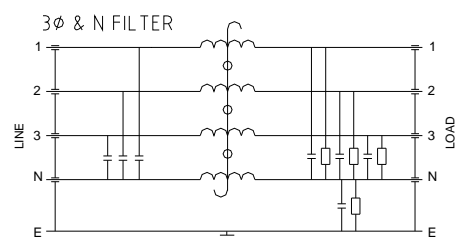
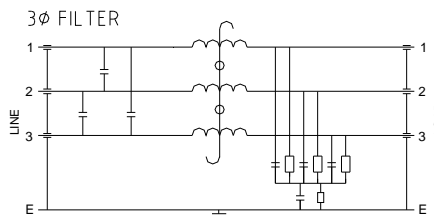
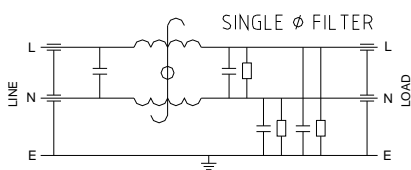

Performance characteristics insertion loss curves

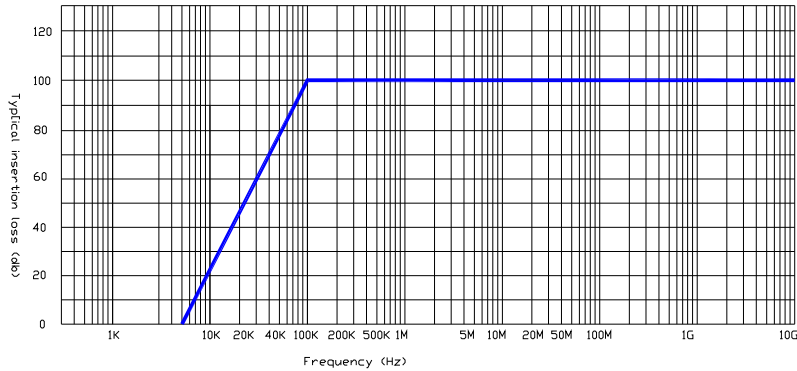

Additional Options – EMC Threaded bulkhead Gland

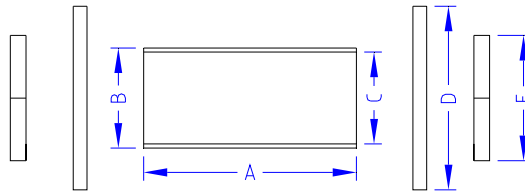

BULKHEAD GLAND DETAILS					
	A	B	C	D (Washer x 2)	E (Lock Nut x 2)
TYPE A	54mm	M25	22mm	44mm	30mm A/F
TYPE B	57mm	M20	17mm	36.5mm	24mm A/F
TYPE C	60mm	M32	29mm	TBA	TBA
TYPE D	60mm	M50	45mm	TBA	TBA
CUSTOM	Total EMC are able to supply custom gland options if required, please advise if you require custom gland solution.				

Part number / Ordering information

\*\*\*/\*/LE/\*

\*\*\* = Amp Rating of filter  
 \*\* = LE Low earth leakage

\* = No of Lines on filter (2,3,4)  
 T = Transient Protection, - = None

Example: 016/3/LE/- (This is a 16A 3 line LE unit with no protection)

In addition to the standard range of filters & power supplies, Total EMC Products specialize in the design and manufacture of filters to suit your specific requirements. Due to continuous development Total EMC Products Ltd reserve the right to amend any information contained within this datasheet without prior notice.

© 10/2013 Total EMC Products Ltd. E & OE  
 The contents of the datasheet must not be copied by any means without prior written agreement.

# TE Shielded room filters

Current Ratings: **3,6,10,16,25,32,50,63,80,100,200,225, 400, \*600** AMPS.  
 Operating Voltage: Single Phase, Two Phase & Three Phase. 230V to 440V.A.C.

The TE (TEMPEST) filter range are designed and tested for shielded room requirements, for attenuation from 100kHz – 10GHz at 120dB, this range of filters will also keep attenuating up to 40GHz and beyond. Shielded rooms require high levels of attenuation to ensure no conducted / radiated emissions are either imported or exported from the room. The filters come in 2, 3 or 4 line formats and have current ratings up to 600 Amps per phase. Transient suppression can be added as an option to the filters to give protection against induced transients from EMP sources.

The filters are housed in steel enclosures that are then painted for protection.

*\*Custom options and higher current ratings are available for this range, please contact for details.*



## TYPICAL APPLICATIONS

- Shielded enclosures
- IT installation
- Computer rooms
- Banks
- Military installations
- TEMPEST application

## COMMERCIAL ADVANTAGES

- Assists compliance with the EMC directive
- State of the art technology ensures superior performance
- Competitively priced
- Compact size - Reduced weight - Cost effective component

## TECHNICAL ADVANTAGES

- High current capability - Micro size
- High common & differential mode insertion loss
- Improved low frequency performance
- Optional input transient suppression to suit application

## Technical Specifications

Current (Amps)	No of Lines	Max Voltage / Frequency		Max AC Volt Drop @ Full Load	Typical Earth Leakage mA (Worst case)			Inductance Per Line (Typical) mH	Transient Energy Absorption (Typical)	Storage Temp Range	Operating Temp.	Temp Rise @ Full Load	Termination Type	Weight (Kg) (approx)	
		2 LINE	3 / 4 LINE		Std	LE	400 Hz							2 Line	4 line
3 - 6	2/3/4	275V AC	440V AC	<2V/Line	200	20	200	7	50J Optional	-25 ~ +85°C	-20 - +50°C	<35°C	M5 BOLT	4	10
10 -16					200	20	200	5	75J Optional				M5 BOLT	5	10
25 - 32					500	20	500	3	75J Optional				M6 BOLT	9	10
50 - 63					1000	40	1000	2	75J Optional				M8 BOLT	9	10
80 -100					2000	40	2000	0.7	150J Optional				M10 BOLT	26	20
200					2000	40	4000	0.3	150J Optional				M10 BOLT	29	30
400					4000	80	6000	0.15	200J Optional				M16 BOLT	39	42

## STANDARDS

The TE range of filters are built in accordance with the relevant BS, VDE, UL, CE & CSA safety standards. This range also conforms to MIL-STD 220A and the electrical characteristics of Mil-F-15733. All Total EMC Products filters & power supplies are designed to meet the latest requirements for Health and Safety, Particularly EN 60939-2-2005.

## REGULATIONS

From the 15th of December 2004 all electrical/electronic apparatus - with few exceptions - sold or taken into service within the European Community must comply with the essential requirements of the EMC directive 2004/108/EC. Failure to do so is a criminal offence in the U.K.

Dimensional Data

AMP	LINE 2	A mm	B mm	C mm	D mm	E mm	F mm	G mm	LINE 3	A mms	B mm	C mm	D mm	E mm	F mm	G mm	LINE 4	A mm	B mm	C mm	D mm	E mm	F mm	G mm
3 - 6		400	90	45	20.5	24	57	6.5		370	200	90	32	60	56	6.5		370	200	90	32	60	56	6.5
10 -16		400	90	45	20.5	24	57	6.5		370	200	90	32	60	56	6.5		370	200	90	32	60	56	6.5
25 -32		370	200	90	25	60	56	6.5		370	200	90	32	60	56	6.5		370	200	90	32	60	56	6.5
50 -63		370	200	90	25	60	56	6.5		400	300	120	32	100	51	8.5		400	300	120	32	100	51	8.5
80 -100		560	215	120	32	120	45	8.5		550	410	150	63	120	45	10.5		550	410	150	63	120	45	10.5
200		560	215	120	32	120	45	8.5		550	410	150	63	120	45	10.5		550	410	150	63	120	45	10.5
400		740	410	200	50	150	65	12		970	510	200	50	150	65	12		970	510	200	50	150	65	12

All Dimensions relate to VP filters only.

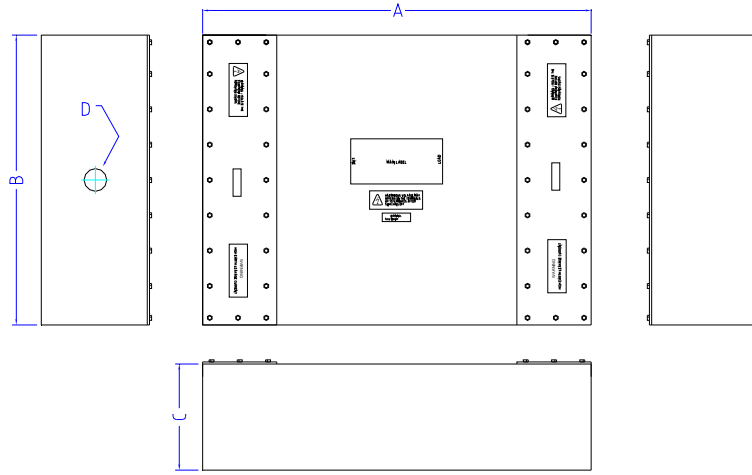

4 Line unit displayed

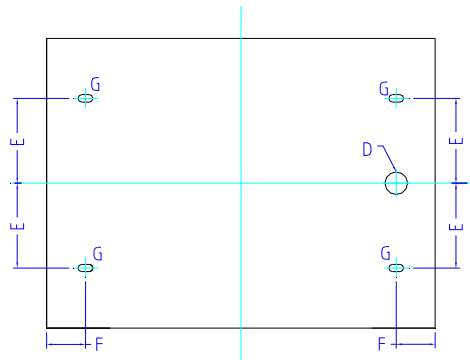

Schematics

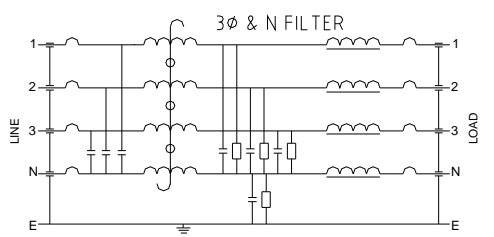
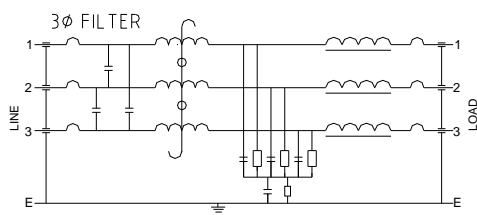
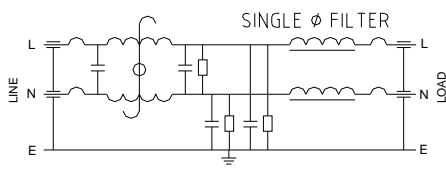

Performance characteristics insertion loss curves

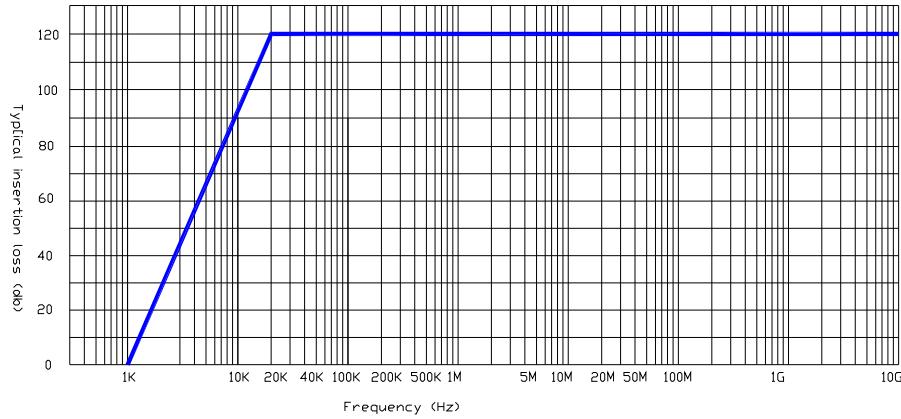

Additional Options – EMC Threaded bulkhead Gland

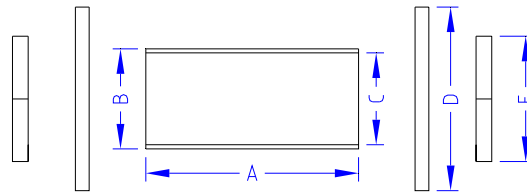

BULKHEAD GLAND DETAILS					
	A	B	C	D (Washer x 2)	E (Lock Nut x 2)
TYPE A	54mm	M25	22mm	44mm	30mm A/F
TYPE B	57mm	M20	17mm	36.5mm	24mm A/F
TYPE C	60mm	M32	29mm	TBA	TBA
TYPE D	60mm	M50	45mm	TBA	TBA
CUSTOM	Total EMC are able to supply custom gland option, please advise if you require custom Gland solution.				

Part number / ordering information

\*\*\*/\*/TE/\*

\*\*\* = Amp Rating of filter  
\*\* = TE, TEMPEST

\* = No of Lines on filter (2,3,4)  
T = Transient Protection, - = None

Example: 016/3/TE/- (This is a 16A 3 line VP unit with no protection)

In addition to the standard range of filters & power supplies, Total EMC Products specialize in the design and manufacture of filters to suit your specific requirements. Due to continuous development Total EMC Products Ltd reserve the right to amend any information contained within this datasheet without prior notice.

© 10/2012 Total EMC Products Ltd. E & OE  
The contents of the datasheet must not be copied by any means without prior written agreement.

# VP Shielded room filters

Current Ratings: **3,6,10,16,25,32,50,63,80,100,200,225, 400, 600, 1000+** AMPS.  
 Operating Voltage: Single Phase, Two Phase & Three Phase. 230V to 440V.A.C.

The VP (Very high performance) filter range are designed and tested for shielded room requirements, for attenuation from 10kHz – 10GHz at 100dB, this range of filters will also keep attenuating up to 40GHz and beyond.

Shielded rooms require high levels of attenuation to ensure no conducted / radiated emissions are either imported or exported from the room. The filters come in 2, 3 or 4 line formats and have current ratings up to 3000Amps per phase. Transient suppression can be added as an option to the filters to give protection against induced transients from EMP sources.

The filters are housed in steel enclosures that are then painted for protection.



## TYPICAL APPLICATIONS

- Shielded enclosures
- IT installation
- Computer rooms
- Banks
- Military installations

## COMMERCIAL ADVANTAGES

- Assists compliance with the EMC directive
- State of the art technology ensures superior performance
- Competitively priced
- Compact size - Reduced weight - Cost effective component

## TECHNICAL ADVANTAGES

- High current capability - Micro size
- High common & differential mode insertion loss
- Improved low frequency performance
- Optional input transient suppression to suit application

## Technical Specifications

Current (Amps)	No of Lines	Max Voltage / Frequency		Max AC Volt Drop @ Full Load	Typical Earth Leakage mA (Worst case)			Inductance Per Line (Typical) mH	Transient Energy Absorption (Typical)	Storage Temp Range	Operating Temp.	Temp Rise @ Full Load	Termination Type	Weight (Kg) (approx)	
		2 LINE	3 / 4 LINE		Std	LE	400 Hz							2 Line	4 line
3 - 6	2/3/4	275V AC	440V AC	<2V/Line	200	20	200	7	50J Optional	-25 ~ +85°C	-20 - +50°C	<35°C	M5 BOLT	4	10
10 -16					200	20	200	5	75J Optional				M5 BOLT	5	10
25 - 32					500	20	500	3	75J Optional				M6 BOLT	9	10
50 - 63					1000	40	1000	2	75J Optional				M8 BOLT	9	10
80 -100					2000	40	2000	0.7	150J Optional				M10 BOLT	26	20
200					2000	40	4000	0.3	150J Optional				M10 BOLT	29	30
400					4000	80	6000	0.15	200J Optional				M16 BOLT	39	42

## STANDARDS

The VP range of filters are built in accordance with the relevant BS, VDE, UL, CE & CSA safety standards. This range also conforms to MIL-STD 220A and the electrical characteristics of Mil-F-15733. All Total EMC Products filters & power supplies are designed to meet the latest requirements for Health and Safety, Particularly EN 60939-2-2005.

## REGULATIONS

From the 15th of December 2004 all electrical/electronic apparatus - with few exceptions - sold or taken into service within the European Community must comply with the essential requirements of the EMC directive 2004/108/EC. Failure to do so is a criminal offence in the U.K.

Dimensional Data

AMP	LINE 2	A mm	B mm	C mm	D mm	E mm	F mm	G mm	LINE 3	A mms	B mm	C mm	D mm	E mm	F mm	G mm	LINE 4	A mm	B mm	C mm	D mm	E mm	F mm	G mm
3 - 6		400	90	45	20.5	24	57	6.5		370	200	90	32	60	56	6.5		370	200	90	32	60	56	6.5
10 -16		400	90	45	20.5	24	57	6.5		370	200	90	32	60	56	6.5		370	200	90	32	60	56	6.5
25 -32		370	200	90	25	60	56	6.5		370	200	90	32	60	56	6.5		370	200	90	32	60	56	6.5
50 -63		370	200	90	25	60	56	6.5		400	300	120	32	100	51	8.5		400	300	120	32	100	51	8.5
80 -100		560	215	120	32	120	45	8.5		550	410	150	63	120	45	10.5		550	410	150	63	120	45	10.5
200		560	215	120	32	120	45	8.5		550	410	150	63	120	45	10.5		550	410	150	63	120	45	10.5
400		740	410	200	50	150	65	12		970	510	200	50	150	65	12		970	510	200	50	150	65	12

All Dimensions relate to VP filters only.

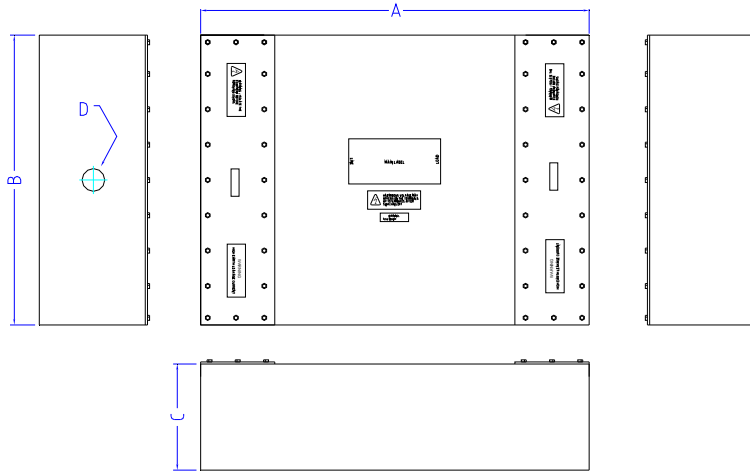

4 Line unit displayed

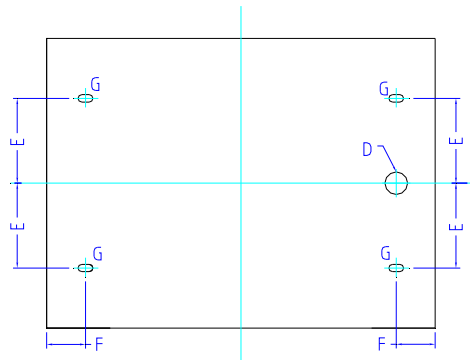

Schematics

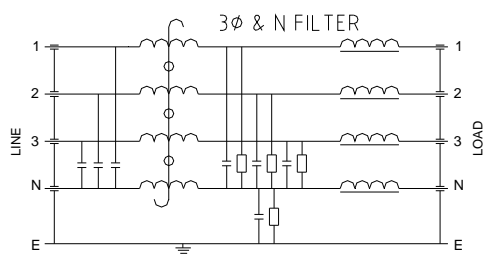
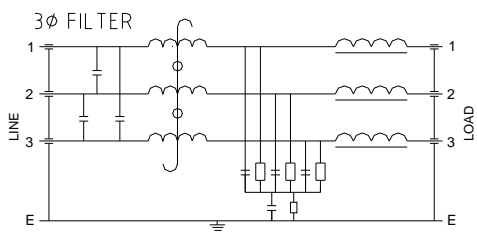
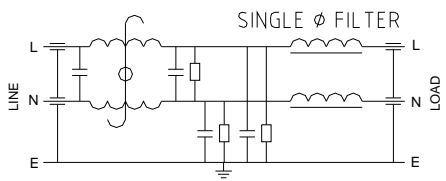

Performance characteristics insertion loss curves

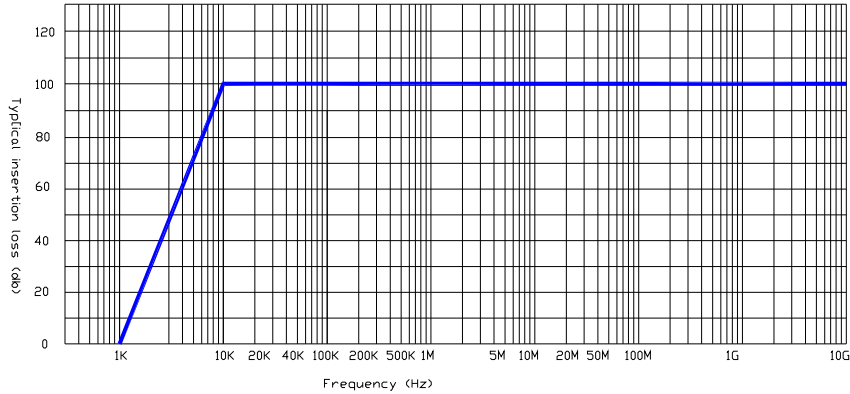

Additional Options – EMC Threaded bulkhead Gland

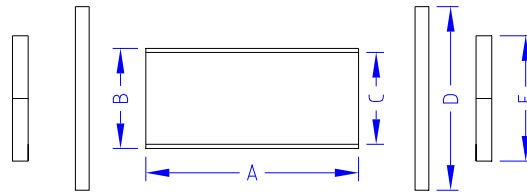

BULKHEAD GLAND DETAILS

	A	B	C	D (Washer x 2)	E (Lock Nut x 2)
TYPE A	54mm	M25	22mm	44mm	30mm A/F
TYPE B	57mm	M20	17mm	36.5mm	24mm A/F
TYPE C	60mm	M32	29mm	TBA	TBA
TYPE D	60mm	M50	45mm	TBA	TBA
CUSTOM	Total EMC are able to supply custom gland options if required, please advise if you require custom Gland solution.				

Part number / ordering information

\*\*\*/\*/VP/\*

\*\*\* = Amp Rating of filter

\* = No of Lines on filter (2,3,4)

\*\* = GP, General Performance

T = Transient Protection, - = None

Example: 016/3/VP/- (This is a 16A 3 line VP unit with no protection)

In addition to the standard range of filters & power supplies, Total EMC Products specialize in the design and manufacture of filters to suit your specific requirements. Due to continuous development Total EMC Products Ltd reserve the right to amend any information contained within this datasheet without prior notice.

© 10/2012 Total EMC Products Ltd. E & OE  
The contents of the datasheet must not be copied by any means without prior written agreement.